

PR[®]



5725

**LED Frequency /
Pulse Converter**

No. 5725V100-UK
From ser. no. 100687001



SIGNALS THE BEST

- DK** ▶ PR electronics A/S tilbyder et bredt program af analoge og digitale signalbehandlingsmoduler til industriel automation. Programmet består af Isolatorer, Displays, Ex-barrierer, Temperaturtransmittere, Universaltransmittere mfl. Vi har modulerne, du kan stole på i selv barske miljøer med elektrisk støj, vibrationer og temperaturudsving, og alle produkter opfylder de strengeste internationale standarder. Vores motto »Signals the Best« er indbegrebet af denne filosofi – og din garanti for kvalitet.
- UK** ▶ PR electronics A/S offers a wide range of analogue and digital signal conditioning devices for industrial automation. The product range includes Isolators, Displays, Ex Interfaces, Temperature Transmitters, and Universal Devices. You can trust our products in the most extreme environments with electrical noise, vibrations and temperature fluctuations, and all products comply with the most exacting international standards. »Signals the Best« is the epitome of our philosophy – and your guarantee for quality.
- FR** ▶ PR electronics A/S offre une large gamme de produits pour le traitement des signaux analogiques et numériques dans tous les domaines industriels. La gamme de produits s'étend des transmetteurs de température aux afficheurs, des isolateurs aux interfaces SI, jusqu'aux modules universels. Vous pouvez compter sur nos produits même dans les conditions d'utilisation sévères, p.ex. bruit électrique, vibrations et fluctuations de température. Tous nos produits sont conformes aux normes internationales les plus strictes. Notre devise »SIGNALS the BEST« c'est notre ligne de conduite - et pour vous l'assurance de la meilleure qualité.
- DE** ▶ PR electronics A/S verfügt über ein breites Produktprogramm an analogen und digitalen Signalverarbeitungsmodulen für die industrielle Automatisierung. Dieses Programm umfasst Displays, Temperaturtransmitter, Ex- und galvanische Signaltrenner, und Universalgeräte. Sie können unsere Geräte auch unter extremen Einsatzbedingungen wie elektrisches Rauschen, Erschütterungen und Temperaturschwingungen vertrauen, und alle Produkte von PR electronics werden in Übereinstimmung mit den strengsten internationalen Normen produziert. »Signals the Best« ist Ihre Garantie für Qualität!

LED FREQUENCY / PULSE CONVERTER

5725

CONTENTS

Warning	4
Safety instructions.....	5
EC declaration of conformity	7
Front and back layout	8
Application	9
Technical characteristics	9
Mounting / installation.....	9
Applications.....	10
Electrical specifications.....	11
Order: 5725	11
Sensor error indication, inside and outside range	15
Connections	16
Block diagram	17
Routing diagram for 5725A.....	19
Routing diagram for 5725D.....	21
Scrolling help texts.....	22
Configuration / operating the function keys	24
Graphic depiction of the relay function setpoint	26



GENERAL

WARNING

This device is designed for connection to hazardous electric voltages. Ignoring this warning can result in severe personal injury or mechanical damage. To avoid the risk of electric shock and fire, the safety instructions of this manual must be observed and the guidelines followed. The specifications must not be exceeded, and the device must only be applied as described in the following. Prior to the commissioning of the device, this manual must be examined carefully. Only qualified personnel (technicians) should install this device.

If the equipment is used in a manner not specified by the manufacturer, the protection provided by the equipment may be impaired.



**HAZARD-
OUS
VOLTAGE**



WARNING

Until the device is fixed, do not connect hazardous voltages to the device.

The following operations should only be carried out on a disconnected device and under ESD safe conditions:

Troubleshooting the device.

Repair of the device must be done by PR electronics A/S only.

SYMBOL IDENTIFICATION



Triangle with an exclamation mark: Warning / demand. Potentially lethal situations.



The CE mark proves the compliance of the device with the essential requirements of the directives.

SAFETY INSTRUCTIONS

DEFINITIONS

Hazardous voltages have been defined as the ranges: 75 to 1500 Volt DC, and 50 to 1000 Volt AC.

Technicians are qualified persons educated or trained to mount, operate, and also troubleshoot technically correct and in accordance with safety regulations. Operators, being familiar with the contents of this manual, adjust and operate the knobs or potentiometers during normal operation.

RECEIPT AND UNPACKING

Unpack the device without damaging it. The packing should always follow the device until this has been permanently mounted. Check at the receipt of the device whether the type corresponds to the one ordered.

ENVIRONMENT

Avoid direct sunlight, dust, high temperatures, mechanical vibrations and shock, as well as rain and heavy moisture. If necessary, heating in excess of the stated limits for ambient temperatures should be avoided by way of ventilation.

All devices fall under Installation Category II, Pollution Degree 1, and Insulation Class II.

MOUNTING

Only technicians who are familiar with the technical terms, warnings, and instructions in the manual and who are able to follow these should connect the device.

Should there be any doubt as to the correct handling of the device, please contact your local distributor or, alternatively,

PR electronics A/S
www.prelectronics.com

Mounting and connection of the device should comply with national legislation for mounting of electric materials, i.e. wire cross section, protective fuse, and location. Descriptions of Input / Output and supply connections are shown in the block diagram and side label.

The following apply to fixed hazardous voltages-connected devices:

The max. size of the protective fuse is 10 A and, together with a power switch, it shall be easily accessible and close to the device. The power switch shall be marked as the disconnecting unit for the device.

UL INSTALLATION REQUIREMENTS

For use on a flat surface of a type 1 enclosure.

Use 60/75°C copper conductors only.

Enclosure rating (face only)..... Type 4X, UL50E

Max. ambient temperature..... 60°C

Max. wire size, pins 41...46..... AWG 30-16

Max. wire size, others AWG 30-12

UL file number..... E248256

CALIBRATION AND ADJUSTMENT

During calibration and adjustment, the measuring and connection of external voltages must be carried out according to the specifications of this manual. The technician must use tools and instruments that are safe to use.

NORMAL OPERATION

Operators are only allowed to adjust and operate devices that are safely fixed in panels, etc., thus avoiding the danger of personal injury and damage. This means there is no electrical shock hazard, and the device is easily accessible.

CLEANING

When disconnected, the device may be cleaned with a cloth moistened with distilled water.

LIABILITY

To the extent the instructions in this manual are not strictly observed, the customer cannot advance a demand against PR electronics A/S that would otherwise exist according to the concluded sales agreement.

EC DECLARATION OF CONFORMITY

As manufacturer

PR electronics A/S
Lerbakken 10
DK-8410 Rønde

hereby declares that the following product:

Type: 5725
Name: LED frequency / pulse converter

is in conformity with the following directives and standards:

The EMC Directive 2004/108/EC and later amendments

EN 61326-1 : 2006

For specification of the acceptable EMC performance level, refer to the electrical specifications for the device.

The Low Voltage Directive 2006/95/EC and later amendments

EN 61010-1 : 2001

Rønde, 17 February 2011



Kim Rasmussen
Manufacturer's signature

FRONT AND BACK LAYOUT



Picture 1: Front of 5725.

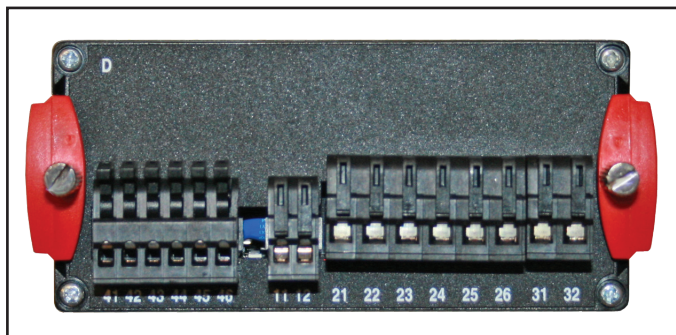

Picture 2: Back of 5725.

LED FREQUENCY / PULSE CONVERTER 5725

- *4-digit 14-segment LED display*
- *Frequency / pulse input*
- *2 relays and analogue output*
- *Universal supply voltage*
- *Programmable via front keys*

Application

- Display for digital readout of frequency input signals.
- Process control with 2 pairs of potential-free change-over relays and analogue output.
- For local readout in extremely wet atmospheres with a specially designed splash-proof cover.

Technical characteristics

- 4-digit LED indicator with 13.8 mm 14-segment characters. Max. display readout -1999...9999 with programmable decimal point and relay ON / OFF indication.
- All standard operational parameters can be adjusted to any application by way of the front function keys.
- Help texts in eight languages can be selected via a menu item.
- A menu item allows the user to minimise the installation test time for the relay outputs by activating/deactivating each relay independently of the input signal.

Mounting / installation

- To be mounted in panel front. The included rubber packing must be mounted between the panel cutout hole and the display front to obtain a protection degree of IP65 (type 4X). For extra protection in extreme environments, the 5725 can be delivered with a specially designed splash-proof cover as accessory.

APPLICATIONS

Input signals:

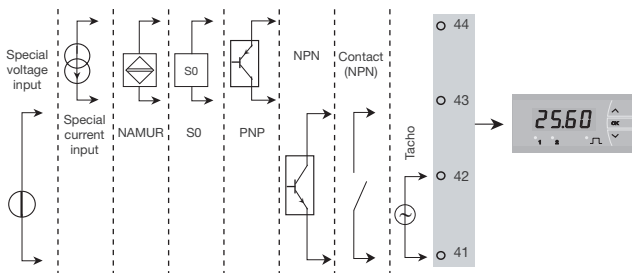

Output signals:

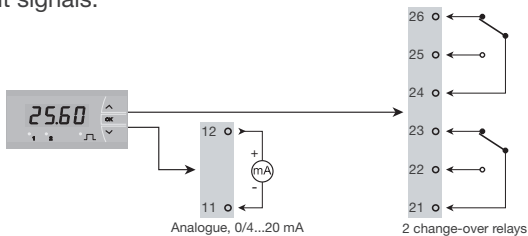

Supply:

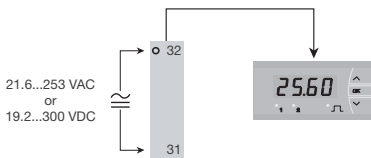

Order: 5725

Type	Version
5725	Standard.....: A
	Analogue output and 2 relays ..: D

Electrical specifications

Specifications range..... -20...+60°C

Storage temperature -40...+85°C

Common specifications:

Supply voltage, universal 21.6...253 VAC, 50...60 Hz or
19.2...300 VDC

Consumption:

Type	Max. consumption
5725A	2.8 W
5725D	3.6 W

Isolation voltage, test / operation 2.3 kVAC / 250 VAC

Signal / noise ratio Min. 60 dB (0...100 kHz)

Calibration temperature..... 20...28°C

Wire size, pin 41...44 (max.)..... 1 x 1.5 mm² stranded wire

Wire size, others (max.)..... 1 x 2.5 mm² stranded wire

Relative humidity < 95% RH (non cond.)

Dimensions (H x W x D) 48 x 96 x 120 mm

Cutout dimensions 44.5 x 91.5 mm

Protection degree (mounted in panel) IP65 / type 4X, UL50E

Weight 230 g

Input:

General:

Frequency range	0.001...50 kHz
Period	999.9...20 μ s
Response time (0...90%, 100...10%)	Period + 0.1 sec.
Max. offset.....	90% of selected max. frequency
Low cut off frequency	0.001 Hz
Low cut off period time	1111 sec.
Min. pulse width (without filter)	25 μ s
Min. period (without filter)	50 μ s
Max. frequency (without filter).....	50 kHz
Min. pulse width (with filter)	10 ms
Min. period (with filter).....	20 ms
Max. frequency (with filter).....	50 Hz

NAMUR input acc. to DIN 19234:

Trig-level LOW	≤ 1.2 mA
Trig-level HIGH	≥ 2.1 mA
Input impedance	$1\text{ k}\Omega \pm 5\%$ ≤ 1.5 nF
Breakage detection	≤ 0.1 mA
Short-circuit detection.....	≥ 7.0 mA
Sensor supply (not configurable)	$8.3\text{ V} \pm 0.2\text{ V}$

Tacho input:

Trig-level LOW	≤ -50 mV
Trig-level HIGH	≥ 50 mV
Input impedance	$\geq 100\text{ k}\Omega \pm 5\%$ ≤ 1.5 nF
Max. input voltage.....	80 VAC pp
Sensor supply	5...17 V

NPN / PNP input:

Trig-level LOW	≤ 4.0 V
Trig-level HIGH	≥ 7.0 V
Input impedance	$3.48\text{ k}\Omega \pm 5\%$ ≤ 1.5 nF
Sensor supply	5...17 V

TTL input:

Trig-level LOW	≤ 0.8 VDC
Trig-level HIGH	≥ 2.0 VDC
Input impedance	≥ 100 kΩ ± 5% ≤ 1.5 nF
Sensor supply	5...17 V

S0 input acc. to DIN 43864:

Trig-level LOW	≤ 2.2 mA
Trig-level HIGH	≥ 9.0 mA
Input impedance	758 Ω ± 15% ≤ 1.5 nF
Sensor supply (not configurable)	17 V ± 0.2 V

Special voltage input

User programmable trig-levels.....	-0.05...6.50 V
Minimum hysteresis	0.05 V
Input impedance	Hi Z: ≥ 100k Ω ± 5% ≤ 1.5 nF Pull up: 3.48 k Ω ± 5% ≤ 1.5 nF Pull down: 3.48 k Ω ± 5% ≤ 1.5 nF
Sensor supply	5...17 V

Special current input

User programmable trig-levels.....	0.0...10.0 mA
Minimum hysteresis	0.2 mA
Input impedance	1k Ω ± 5% ≥ 1.5 nF
Sensor supply	5...17 V

Outputs:**Display:**

Display readout	-1999...9999 (4 digits)
Decimal point	Programmable
Digit height	13.8 mm
Display updating	2.2 times / s
Input outside input range is indicated by.....	Explanatory text

Current output:

Signal range (span).....	0...20 mA
Programmable signal ranges	0...20, 4...20, 20...0 and 20...4 mA
Load (max.).....	20 mA / 800 Ω / 16 VDC
Load stability	$\leq 0.01\%$ of span / 100 Ω
Programmable response time.....	1...60 sec.
Sensor error indication (NAMUR input).....	23 / 0 / 3.5 mA / none
NAMUR NE 43 Up- / Downscale	23 mA / 3.5 mA
Output limitation:	
on 4...20 and 20...4 mA signals.....	3.8...20.5 mA
on 0...20 and 20...0 mA signals.....	0...20.5 mA
Current limit.....	≤ 28 mA

Relay outputs:

Relay function.....	Setpoint
Hysteresis, in % / display counts	0.1...100% / 1...9999
On and Off delay	0...3600 s
Power On delay.....	0...60 sec.
Sensor error indication	Make / Break / Hold
Max. voltage.....	250 VRMS
Max. current	2 A / AC
Max. AC power	500 VA
Max. current at 24 VDC.....	1 A

Marine approval:

Det Norske Veritas, Ships & Offshore Standard for Certification No. 2.4

GOST R approval:

*VNIIM, Cert. no. See www.prelectronics.com

Observed authority requirements:**Standard:**

EMC 2004/108/EC	EN 61326-1
LVD 2006/95/EC.....	EN 61010-1
UL, Standard for Safety	UL 508

* approval pending

Sensor error indication, inside and outside range

Sensor error indication in 5725, only available for NAMUR input:				
Condition	Out of range limit	Relay behaviour	Analogue output value	Display readout
Sensor input type = NAMUR and sensor error detection = ON	>6.9 mA	Set to user defined value: HOLD. ACTIVE. DEACTIVE or NONE	Set to user-defined value (23, 0, 3.5 mA or NONE)	"SE.SH"
	<0.1 mA			"SE.BR"

Input out of range indication		
Valid measurement range:	Out of range limit	Display readout
0.001 Hz - 50 kHz (16 min. 40 sec. - 50 kHz)	<0.0009 Hz (18 min. 31 sec.) - equals "Low cut off time"	"IN.LO"
	>50.5 kHz	"IN.HI"
0.005 ms - 999.9 s	>1111 s (18 min. 31 sec.) - equals "Low cut off time"	"IN.LO"
	<19.8 µs	"IN.HI"

Display out of range Indication		
Valid display value range:	Out of range limit	Display readout
-1999 to 9999	< -1999	"-1.9.9.9." - flashing
	> 9999	"9.9.9.9." - flashing

Hardware error indication		
Error explanation	Error cause	Display readout
Error in internal communication (SPI etc.)	Permanent error in intercommunication between microcontrollers	"HW.ER"
Error in checksum test of the configuration in RAM	Error in RAM	"RA.ER"
Error in checksum test of the configuration in EEPROM	Error in EEPROM	"EE.ER"
Error in OK check or checksum test of the calibration data in FLASH	Error in FLASH or Calibration has not been performed or Calibration data in FLASH are corrupt	"NO.CA"

! Error indications in the display blink once a second. The help text explains the error.

CONNECTIONS

Supply:

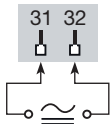

Inputs:

Special current

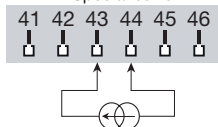

Special voltage

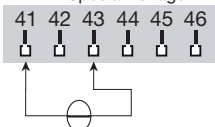

Tacho

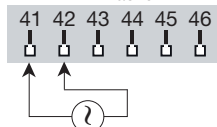

PNP

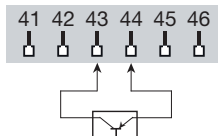

NPN

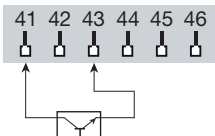

Contact (NPN)

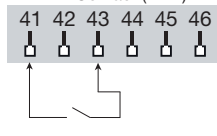

NAMUR

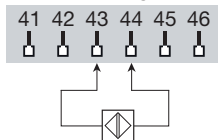

S0

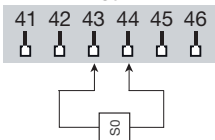

Output:

Current

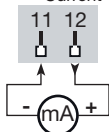

Relays

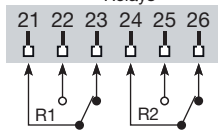

BLOCK DIAGRAM

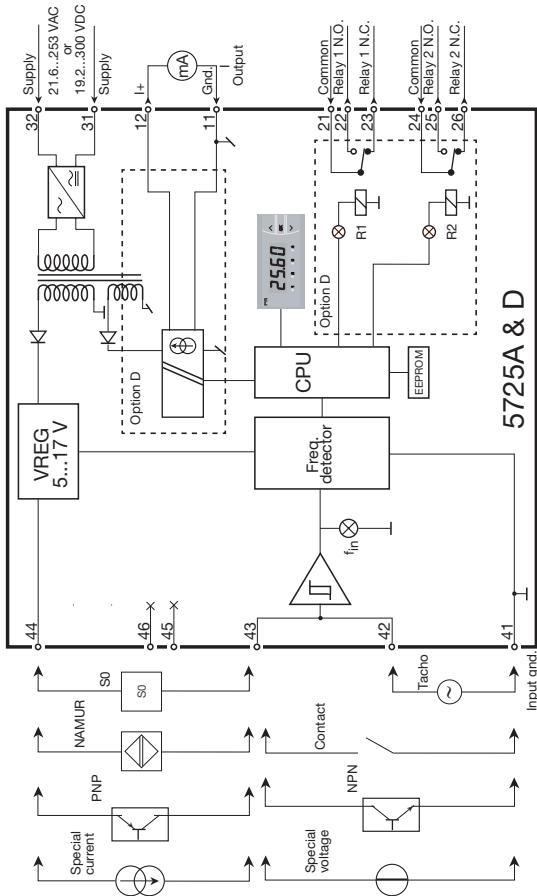

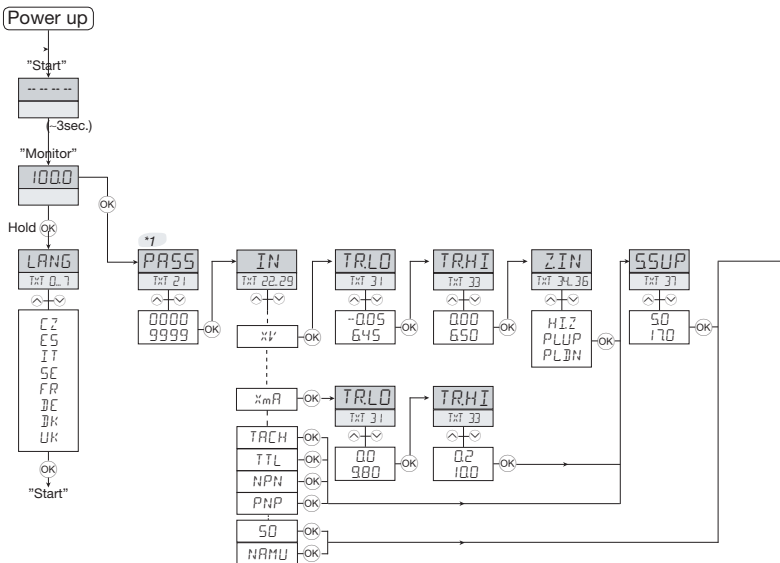

*1 Only visible if password is enabled
($EPAS = YES$)

*2

*3 Password 5000...9999:
FastSet and Relay Test features disabled.
(FastSet menus show the actual setpoints).

*4 Displays either Hz/kHz or s/ms for 1 sec.
before actual value is displayed.
When value hits digit-limit while scrolling,
either Hz/kHz or s/ms is displayed again for
1 sec. to show the user that the new range
is active.

ROUTING DIAGRAM FOR 5725A

If no key is activated for 2 minutes, the display returns to default state "Monitor" without saving configuration changes.

⬆ Increase value / choose next parameter

⬇ Decrease value / choose previous parameter

⊗ Accept the chosen parameter and go to the next menu

Hold ⊗ Back to previous menu / return to default state "Monitor" without saving.

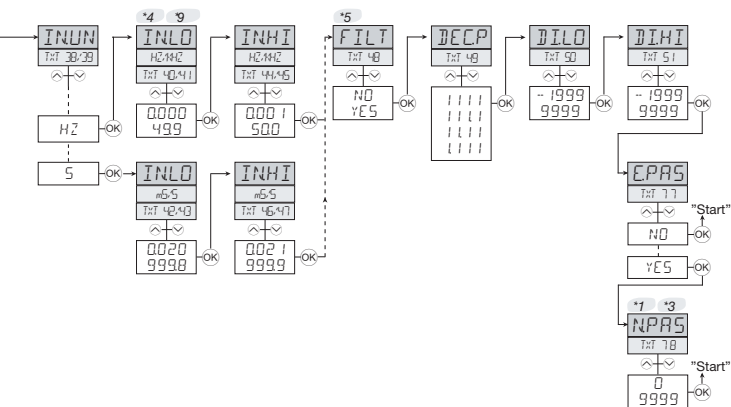

*5 Only visible if max. (INLO, INHI)
≤ 50 Hz or ≥ 20 ms

Default if visible = YES, else deactivated.

*6 Range depends on selected display scaling.

*8

*9 Minimum INHI value is automatically
limited to 1 display count above INLO

*7

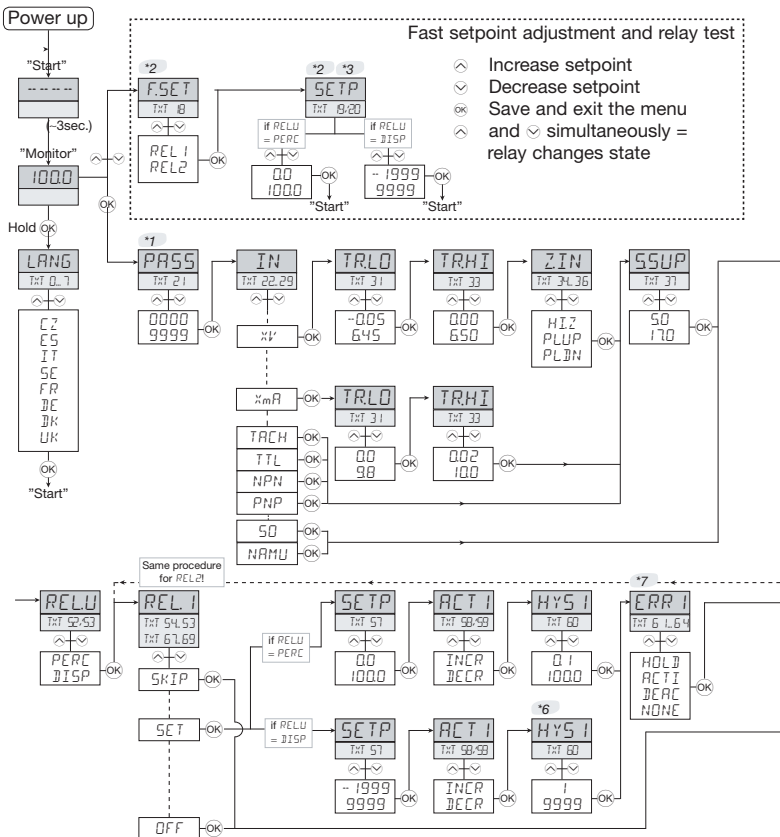

*1 Only visible if password is enabled
(EPAS = YES)

*2 5725D

*3 Password 5000...9999:
FastSet and Relay Test features disabled.
(FastSet menus show the actual setpoints).

*4 Displays either Hz/kHz or s/ms for 1 sec.
before actual value is displayed.
When value hits digit-limit while scrolling,
either Hz/kHz or s/ms is displayed again for
1 sec. to show the user that the new range
is active.

ROUTING DIAGRAM FOR 5725D

If no key is activated for 2 minutes, the display returns to default state "Monitor" without saving configuration changes.

⬆ Increase value / choose next parameter

⬇ Decrease value / choose previous parameter

⊗ Accept the chosen parameter and go to the next menu

⌂ Back to previous menu / return to default state "Monitor" without saving.

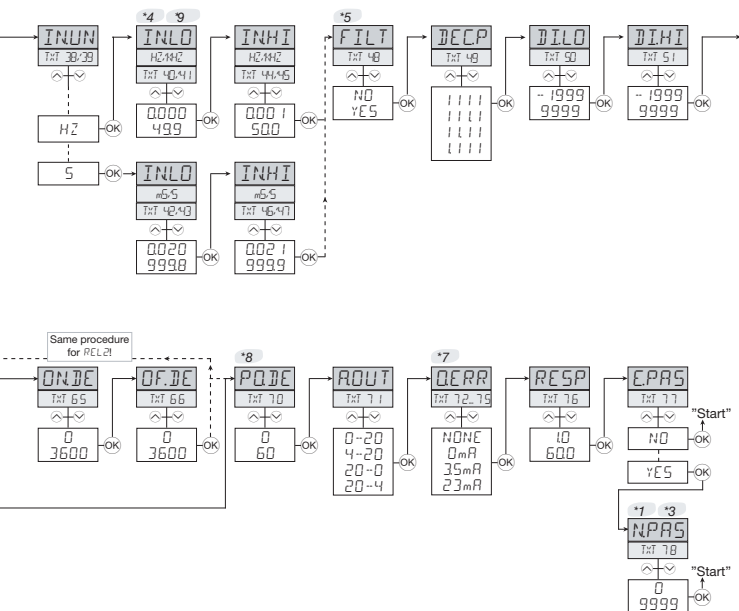

*5 Only visible if max. (INLO, INHI) ≤ 50 Hz or ≥ 20 ms

Default if visible = YES, else deactivated.

*6 Range depends on selected display scaling.

*7 Only visible for NAMUR input.

0mA only visible for ROUT = 0-20 or 20-0

35mA only visible for ROUT = 4-20 or 20-4

*8 Not visible if both relay functions are OFF.

*9 Minimum INHI value is automatically limited to 1 display count above INLO

SCROLLING HELP TEXTS

Top line	Scrolling text	TEXT NR	TR.LO	(when special voltage input is selected)	
Language menu			xxxx	SET LOW TRIGGER LEVEL IN VOLT	30
UK	UK - SELECT ENGLISH HELP TEXT	0	TR.LO (when special current input is selected)		
DK	DK - VÆLG DANSK HJÆLPETEKST	1	xxxx	SET LOW TRIGGER LEVEL IN mA	31
DE	DE - WÄHLE DEUTSCHEN HILFETEXT	2	TR.HI (when special voltage input is selected)		
FR	FR - SELECTION TEXTE D'AIDE EN FRANCAIS	3	xxxx	SET HIGH TRIGGER LEVEL IN VOLT	32
SE	SE - VALJ SVENSK HJALPTEXT	4	TR.HI (when special current input is selected)		
IT	IT - SELEZIONARE TESTI DI AIUTO ITALIANI	5	xxxx	SET HIGH TRIGGER LEVEL IN mA	33
ES	ES - SELECCIONAR TEXTO DE AYUDA EN ESPANOL	6	Z.IN (when special voltage input is selected)		
CZ	CZ - VYBER CESKOU NAPOVEDU	7	HI.Z	SET INPUT RESISTANCE HIGH	34
Error indication			PL.UP	SET INPUT PULL UP	35
(when active, labels are flashing @ app. 1 Hz)			PL.DN	SET INPUT PULL DOWN	36
SE.BR	SENSOR WIRE BREAKAGE	8	S.SUP (not when NAMUR or S0 input is selected)		
IN.HI	INPUT OVERRANGE	9	xxxx	SET SENSOR SUPPLY VOLTAGE	
SE.SH	SENSOR SHORT CIRCUIT	0	IN.UN		
IN.LO	INPUT UNDERRANGE	11	HZ	SET INPUT UNIT FOR FREQUENCY	38
9.9.9.9.	DISPLAY OVERRANGE	12	S	SET INPUT UNIT FOR PERIOD TIME	39
-1.9.9.9.	DISPLAY UNDERRANGE	13	IN.LO		
HW.ER	HARDWARE ERROR	14	xxxx	SET INPUT RANGE LOW IN HZ	40
EE.ER	EEPROM ERROR - CHECK CONFIGURATION	15	xxxx	SET INPUT RANGE LOW IN KHZ	41
RA.ER	RAM MEMORY ERROR	16	xxxx	SET INPUT RANGE LOW IN S	42
NO.CA	DEVICE NOT CALIBRATED	17	xxxx	SET INPUT RANGE LOW IN mS	43
Fastset Menu			IN.HI		
F.SET			xxxx	SET INPUT RANGE HIGH IN HZ	44
REL1	FAST SET MENU - SELECT RELAY	8	xxxx	SET INPUT RANGE HIGH IN KHZ	45
REL2	FAST SET MENU - SELECT RELAY	8	xxxx	SET INPUT RANGE HIGH IN S	46
SETP (if fastset is enabled)			xxxx	SET INPUT RANGE HIGH IN mS	47
xxxx	RELAY SETPOINT - PRESS OK TO SAVE	8	FILT		
SETP (if fastset is disabled)			NO	ENABLE INPUT FILTER	48
xxxxx	RELAY SETPOINT - READ ONLY	20	YES	ENABLE INPUT FILTER	48
Configuration setup			DEC.P		
PASS			1111	DECIMAL POINT POSITION	49
xxxx	SET CORRECT PASSWORD	21	111.1	DECIMAL POINT POSITION	49
IN			11.11	DECIMAL POINT POSITION	49
PNP	PNP SENSOR INPUT	22	1.111	DECIMAL POINT POSITION	49
NPN	NPN SENSOR INPUT	23	DI.LO		
TTL	TTL SENSOR INPUT	24	xxxx	DISPLAY READOUT LOW	50
NAMU	NAMUR SENSOR INPUT	25	DI.HI		
S0	S0 SENSOR INPUT	26	xxxx	DISPLAY READOUT HIGH	51
TACH	TACHO SENSOR INPUT	27			
XmA	SPECIAL CURRENT SENSOR INPUT	28			
XV	SPECIAL VOLTAGE SENSOR INPUT	29			

REL.U		
PERC	SET RELAY IN PERCENTAGE	52
DISP	SET RELAY IN DISPLAY UNITS	53
REL1		
OFF	RELAY 1 DISABLED	54
SETP	ENTER RELAY 1 SETUP	55
SKIP	SKIP RELAY 1 SETUP	56
SETP		
xxxx	RELAY SETPOINT	57
ACT1		
INCR	ACTIVATE AT INCREASING SIGNAL	58
DECR	ACTIVATE AT DECREASING SIGNAL	59
HYS1		
xxxx	RELAY HYSTERESIS	60
ERR1		
HOLD	HOLD RELAY AT ERROR	61
ACTI	ACTIVATE RELAY AT ERROR	62
DEAC	DEACTIVATE RELAY AT ERROR	63
NONE	UNDEFINED STATUS AT ERROR	64
ON.DE		
xxxx	RELAY ON-DELAY IN SECONDS	65
OF.DE		
xxxx	RELAY OFF-DELAY IN SECONDS	66
REL2		
OFF	RELAY 2 DISABLED	67
SETP	ENTER RELAY 2 SETUP	68
SKIP	SKIP RELAY 2 SETUP	69
SETP		
xxxx	RELAY SETPOINT	57
ACT2		
INCR	ACTIVATE AT INCREASING SIGNAL	58
DECR	ACTIVATE AT DECREASING SIGNAL	59
HYS2		
xxxx	RELAY HYSTERESIS	60
ERR2		
HOLD	HOLD RELAY AT ERROR	61
ACTI	ACTIVATE RELAY AT ERROR	62
DEAC	DEACTIVATE RELAY AT ERROR	63
NONE	UNDEFINED STATUS AT ERROR	64
ON.DE		
xxxx	RELAY ON-DELAY IN SECONDS	65

OF.DE		
xxxx	RELAY OFF-DELAY IN SECONDS	66
PO.DE		
xxxx	RELAY POWER ON DELAY IN SECONDS	70
A.OUT		
20-4	OUTPUT RANGE IN mA	71
20-0	OUTPUT RANGE IN mA	71
4-20	OUTPUT RANGE IN mA	71
0-20	OUTPUT RANGE IN mA	71
O.ERR		
23mA	NAMUR NE43 UPSCALE AT ERROR	72
3.5mA	NAMUR NE43 DOWNSCALE AT ERROR	73
0mA	DOWNSCALE AT ERROR	74
NONE	UNDEFINED OUTPUT AT ERROR	75
RESP		
xxxx	ANALOG OUTPUT RESPONSE TIME IN SECONDS	76
E.PAS		
NO	ENABLE PASSWORD PROTECTION	77
YES	ENABLE PASSWORD PROTECTION	77
N.PAS	(when password enabled)	
xxxx	SELECT NEW PASSWORD	78



CONFIGURATION / OPERATING



THE FUNCTION KEYS

Documentation for the routing diagram

In general:

When configuring the display you are guided through all parameters, allowing you to choose the settings which fit the application. For each menu there is a scrolling help text which is automatically shown in the display if no key has been activated for appr. 5 seconds.





Configuration is carried out by way of the 3 function keys   and .

 will increase the numerical value or choose the next parameter.  will decrease the numerical value or choose the previous parameter.  will accept the chosen value and go to the next menu. If a function does not exist in the hardware, all parameters belonging to that function will be skipped in order to make configuration as simple as possible. The configuration will not be saved until the end of the menu structure when the display shows ----.

Pressing and holding  will return to the previous menu or go back to the default state ("Monitor") without saving the changed values or parameters.

If no key is activated for 2 minutes, the display will return to the default state ("Monitor") without saving the changed values or parameters.

Furhter explanations:

Fast setpoint adjustment and relay test: These menus are interactive and allow you to adjust the setpoints while the display is measuring the input signal. The diodes will then indicate when the relays change state, thus easing the setpoint adjustment in many situations. By activating  and  simultaneously, a relay test will be initiated and the relay will change state. The setpoint adjustment will be saved by a quick press of . Holding down  for more that 0.5 seconds will return the display to the default state ("Monitor") without changing the setpoint.

Password protection: Using a password will block access to the menu and parameters. There are two levels of password protection. Passwords between 0000 and 4999 allow access to the fast setpoint adjustment and relay test menus (using this password blocks access to all other parts of the menu). Passwords between 5000 and 9999 block access to all parts of the menu, fast setpoint and relay test (current setpoint is still shown). Default password 2008 allows access to all configuration menus.

Graphic depiction of the relay function setpoint

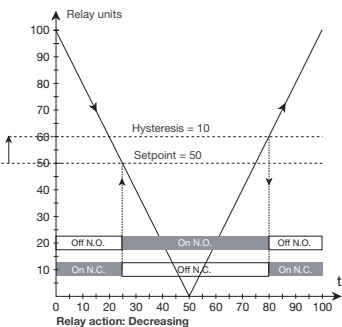
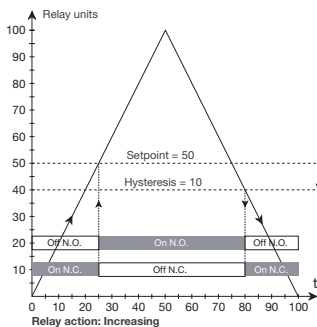



Displays Programmable displays with a wide selection of inputs and outputs for display of temperature, volume and weight, etc. Feature linearisation, scaling, and difference measurement functions for programming via PReset software.



Ex interfaces Interfaces for analogue and digital signals as well as HART® signals between sensors / I/P converters / frequency signals and control systems in Ex zone 0, 1 & 2 and for some devices in zone 20, 21 & 22.



Isolation Galvanic isolators for analogue and digital signals as well as HART® signals. A wide product range with both loop-powered and universal isolators featuring linearisation, inversion, and scaling of output signals.



Temperature A wide selection of transmitters for DIN form B mounting and DIN rail devices with analogue and digital bus communication ranging from application-specific to universal transmitters.





Universal PC or front programmable devices with universal options for input, output and supply. This range offers a number of advanced features such as process calibration, linearisation and auto-diagnosis.



  www.preelectronics.fr
 sales@preelectronics.fr

  www.preelectronics.de
 sales@preelectronics.de

  www.preelectronics.es
 sales@preelectronics.es

  www.preelectronics.it
 sales@preelectronics.it

  www.preelectronics.se
 sales@preelectronics.se

  www.preelectronics.co.uk
 sales@preelectronics.co.uk

  www.preelectronics.com
 sales@preelectronics.com

Head office

Denmark
PR electronics A/S
Lerbakken 10
DK-8410 Rønde

www.preelectronics.com
sales@preelectronics.dk
tel. +45 86 37 26 77
fax +45 86 37 30 85



QUALITY SYSTEM AND ENVIRONMENTAL MANAGEMENT SYSTEM
DS/EN ISO 9001
DS/EN ISO 14001

